

# COLOR DISPLAY WIFI WEATHER STATION

## Operation Manual

**Model: WS2910**

Thank you for purchasing this Color Display Wi-Fi Weather Station! This device provides accurate weather readings and is Wi-Fi capable to stream data from the weather station to Internet based weather services.

This manual will guide you, step-by-step, through setting up your weather station and console, and understanding the operation of your weather station. Use this manual to become familiar with your professional weather station and save it for future reference.





- \* Please scan the QR code to read English manual and keep it for future reference
- \* Bitte scannen Sie den QR-Code zudeutsche Anleitung lesen und aufbewahren füZukunftsbezug
- \* Si prega di scansionare il codice QR perleggi il manuale italiano e conservalo perReferenza futura

## Instruction manuals

<https://www.ecowitt.com/support/download/29>

## Help

Our product is continuously changing and improving, particularly online services and associated applications. To download the latest manual and additional help, please contact our technical support team:

[support@ecowitt.com](mailto:support@ecowitt.com)

[support.eu@ecowitt.net](mailto:support.eu@ecowitt.net) (EU/UK)



MADE IN CHINA

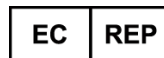

AC WORKS CONSULTING Srl  
Via Vilfredo Pareto 125,47521  
Casena(FC),ITALY

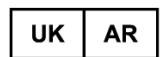

HUA TENG LIMITED  
3 Glass Street, Hanley, Stoke On Trent,  
ST1 2ET United Kingdom

# 1 Table of Contents

|  |    |
|--|----|
| 1 TABLE OF CONTENTS .....                                | 3  |
| 2 WARNINGS AND CAUTIONS .....                            | 5  |
| 3 UNPACKING .....  | 6  |
| 4 FEATURES .....   | 7  |
| 5 SET UP GUIDE .....                                     | 10 |
| 5.1 PRE INSTALLATION CHECKOUT .....                      | 10 |
| 5.2 SITE SURVEY .....                                    | 10 |
| 5.3 SENSOR PACKAGE ASSEMBLY .....                        | 11 |
| 5.3.1 Install U-bolts and metal plate .....              | 12 |
| 5.3.2 Install wind vane .....                            | 13 |
| 5.3.3 Install wind speed cups .....                      | 14 |
| 5.3.4 Install Batteries in sensor package .....          | 14 |
| 5.3.5 Mount assembled outdoor sensor package .....       | 15 |
| 5.3.6 Reset Button and Transmitter LED .....             | 18 |
| 5.4 BEST PRACTICES FOR WIRELESS COMMUNICATION .....      | 18 |
| 5.5 DISPLAY CONSOLE .....                                | 19 |
| 5.5.1 Vertical Desk Stand .....                          | 21 |
| 6 DISPLAY CONSOLE OPERATION .....                        | 22 |
| 6.1 SCREEN DISPLAY .....                                 | 22 |
| 6.2 CONSOLE INITIALIZATION .....                         | 23 |
| 6.2.1 Button functions .....                             | 23 |
| 6.3 SETTING MODE .....                                   | 25 |
| 6.4 BAROMETRIC PRESSURE DISPLAY .....                    | 27 |
| 6.4.1 Viewing Absolute vs. Relative Pressure .....       | 27 |
| 6.4.2 Rate of Change of Pressure Graph .....             | 28 |
| 6.4.3 Viewing Pressure History .....                     | 28 |
| 6.4.4 Relative Pressure Calibration Discussion .....     | 28 |
| 6.5 RAIN DISPLAY .....                                   | 29 |
| 6.5.1 Rain Increments of Measure .....                   | 29 |
| 6.5.2 Resetting Rain .....                               | 29 |
| 6.5.3 Increments of Rain Definitions .....               | 29 |
| 6.6 WIND DISPLAY .....                                   | 30 |
| 6.7 TEMPERATURE DISPLAY .....                            | 30 |
| 6.7.1 Wind Chill, Dew Point and Heat Index Display ..... | 30 |
| 6.8 ALARM MODE .....                                     | 30 |
| 6.8.1 Display of Alarm value .....                       | 30 |

|   |    |
|---|----|
| 6.8.2 Alarm mode setting .....                                | 31 |
| 6.8.3 Alarm Setting Order .....                               | 31 |
| 6.9 MAX/MIN MODE .....  | 32 |
| 6.9.1 Viewing Max/Min Values .....                            | 32 |
| 6.9.2 Calibration mode .....                                  | 34 |
| 6.9.3 Calibration Discussion .....                            | 34 |
| 6.10 OTHER FEATURES .....                                     | 38 |
| 6.10.1 Factory Reset/Clear Memory .....                       | 38 |
| 6.11 RESYNCHRONIZE WIRELESS SENSOR .....                      | 39 |
| 6.12 BACKLIGHT OPERATION .....                                | 39 |
| 6.12.1 Tendency indicators .....                              | 39 |
| 6.12.2 Wireless Signal Strength Indicator .....               | 40 |
| 6.12.3 Weather Forecasting .....                              | 40 |
| 6.12.4 Storm Alert .....                                      | 41 |
| 6.12.5 Weather Forecasting Description and Limitations .....  | 41 |
| 6.12.6 Snooze .....   | 41 |
| 7 PUBLISHING TO INTERNET WEATHER SERVICES .....               | 42 |
| 7.1 CONNECTING THE WEATHER STATION CONSOLE TO WI-FI .....     | 43 |
| 7.1.1 Configure Device – Connect your console with WIFI ..... | 43 |
| 7.2 ADDING AND WEATHER SERVICES .....                         | 45 |
| 7.2.1 Ecowitt Weather .....                                   | 46 |
| 7.2.2 Viewing data on ecowitt.net .....                       | 48 |
| 7.3 WEATHER UNDERGROUND .....                                 | 51 |
| 7.4 VIEWING DATA ON WUNDERGROUND.COM .....                    | 55 |
| 7.5 DEVICE LIST .....   | 58 |
| 7.6 MANAGE WUNDERGROUND .....                                 | 58 |
| 7.7 SETTINGS .....  | 59 |
| 7.8 MANAGE ECOWITT .....                                      | 60 |
| 8 MAINTENANCE .....   | 61 |
| 9 TROUBLESHOOTING GUIDE .....                                 | 63 |
| 10 GLOSSARY OF COMMON TERMS .....                             | 67 |
| 11 SPECIFICATIONS .....                                       | 70 |
| 12 WARRANTY INFORMATION .....                                 | 72 |

## 2 Warnings and Cautions

### Warning:

- Any metal object may attract a lightning strike, including your weather station mounting pole. Never install the weather station in a storm.
- If you are mounting the weather station to a house or structure, consult a licensed electrician for proper grounding. A direct lightning strike to a metal pole can damage or destroy your home.
- Installing your weather station in a high location may result in injury or death. Perform as much of the initial check out and operation on the ground and inside a building or home. Only install the weather station on a clear, dry, day.

### 3 Unpacking

Open your weather station box and inspect that the contents are intact (nothing broken) and complete (nothing missing). Inside you should find the following:

| QT | Item Description   |
|----|--|
| 1  | Display Console  |
| 1  | Outdoor Sensor Body with built-in: Thermo-hygrometer / Rain Gauge / Wind Speed Sensor/ Wind Direction Sensor, Light and UV sensor, Solar panel |
| 1  | Wind speed cups (to be attached to outdoor sensor body)  |
| 1  | Wind vane (to be attached to outdoor sensor body)  |
| 2  | U-Bolts for mounting on a pole   |
| 4  | Threaded nuts for U-Bolts (M6 size)  |
| 1  | Metal mounting plate to be used with U-Bolts   |
| 1  | Wrench for M6 bolts  |
| 1  | AC adapter   |
| 1  | User manual (this manual)  |

**Table 1: Package content**

If components are missing from the package, or broken, please contact customer service to resolve the issue.

**Note:** Batteries for the outdoor sensor package are **not included**. You will need 2 AA size batteries, alkaline or Lithium batteries (Lithium recommended for colder climates).

**Note:** The console operates using an AC adapter. The included adapter is a switching-type adapter and can generate a small amount of electrical interference with the RF reception in the console, when placed too close to the console. Please keep the console display at least 2 ft. or 0.5 m away from the power adapter to ensure best RF reception from the outdoor sensor package.

## 4 Features

- Color display with 8 touch buttons
- Calendar (Month/date, 2000-2099 Default Year 2016)
- Time (hour/minute)
- Indoor/Outdoor Temperature and Humidity with trend
- Wind speed, gust speed, and wind direction
- Absolute and Relative barometric pressure
- Display rainfall in rate, event, day, week, month and total.
- Calculated wind chill, dew point and heat index display
- Solar light intensity and UV index
- Selectable display units for each sensor: C or F (temperature); mph, km/h, m/s, knots or Beaufort (wind speed); inHg, hPa or mmHg (pressure); in or mm (rainfall); lux, fc or w/m<sup>2</sup> (solar lighting)
- Barometric history graph (12, 24, 48, or 72 hr.)
- Maximum and minimum values for indoor / outdoor temperature and humidity
- High/low alarm options for sensors
- Weather forecast: Sunny, Partly sunny, Cloudy, Rainy, Stormy and Snowy
- User accuracy calibration supported
- Automatically to saved user set parameters (unit, calibration data, alarm data...) in to EEPROM
- High/Mid/Off backlight controlled
- When DC power adapter is connected, back light is on permanently. When only battery operated, back light is turned on only when button is pressed and auto time out is 15s.
- Additional/optional sensors supported:
  - Up to 8 WH31 multi-channel temperature and humidity sensors
  - Up to 2 WH41/WH43 PM2.5 air quality sensors
- Pushes sensor data to cloud weather services:
  - <https://www.ecowitt.net>

- <https://www.wunderground.com>
- <https://www.weathercloud.com/>
- <https://www.wow.com>
- Custom sites using either Wunderground or Ecowitt protocol. Contact the Customer Support department for assistance.
- Data storage service on Ecowitt Weather server: <https://ecowitt.net>
  - Data storing interval:
    - by day: 5 minutes
    - by week: 30 minutes
    - by month: 4 hours
    - by year: 1 day
  - Stores data for past three months at 5-minute intervals
  - Stores data for past one year at 30-minute intervals
  - Stores data for past two year at 4-hour intervals

**Note:** The optional WH31 and WH41/WH43 can be purchased separately. If more info needed, please visit our website: <http://www.ecowitt.com>. Make sure to select the model of the units with the same RF frequency as your gateway (the frequency is different for various countries because of regulations).

The console only supports to push the optional WH31 and WH41/WH43 sensor data to Ecowitt Weather Server. The optional sensors data will not display on the console.

**Note:** To pair the optional sensors with the WS2910 console, please follow the below operations:

1. Ensure that you have uploaded your data to [ecowitt.net](https://ecowitt.net).
2. Place the optional sensor next to the console(keep 5-10ft away from each other).



3. Install batteries on the sensor and wait for 1-2 minutes.
4. Refresh the Dashboard page on [ecowitt.net](http://ecowitt.net) and check whether the optional sensor data will appear.

# 5 Set up Guide

## 5.1 Pre Installation Checkout

To complete assembly you will need a Philips screwdriver (size PH0) and a wrench (size M6; included in package).

**Note:** We suggest you assemble all components of the weather station, including console in one location so you can easily test functionality. After testing, place the outdoor sensor package in the desired location. Note, however, that movement during assembly, and movement after assembly can cause the rain sensor to “falsely” register rain. It is therefore best if you do not connect the console to any Internet services until you have reset these false readings using the console. The errant values may be hard to remove from Internet services if you do not reset first.

**Attention:**

- Follow suggested order for battery installation (outdoor sensor first, console second)
- Ensure batteries are installed with correct polarity (+/-)
- Do not mix old and new batteries
- Do not use rechargeable batteries
- If outdoor temperature may go below 32F or 0C for prolonged periods, Lithium based batteries are suggested over alkaline type batteries for the outdoor sensor array

## 5.2 Site Survey

Perform a site survey before installing the weather station. Consider the following:

1. You must clean the rain gauge every few months and change the batteries every 2-3 years. Provide easy access to the weather station.
2. Avoid radiant heat transfer from buildings and structures. In general, install the sensor array at least 5’ or 1.52m from any building,

structure, ground, or roof top.

3. Avoid wind and rain obstructions. The rule of thumb is to install the sensor array at least four times the distance of the height of the tallest obstruction. For example, if the building is 20' or 6.10m tall and the mounting pole is 6' or 1.83m tall, install the sensor array  $4 \times (20 - 6)' = 56'$  or  $4 \times (6.1 - 1.83) = 17.08\text{m}$  away.
4. Mount the sensor array in direct sunlight for accurate temperature readings.
5. Installing the weather station over sprinkler systems or other unnatural vegetation may affect temperature and humidity readings. We suggest mounting the sensor array over natural vegetation.
6. Wireless Range. Radio communication between receiver and transmitter in an open field can reach a distance of up to 330 feet or 100 meter, providing there are no interfering obstacles such as buildings, trees, vehicles and high voltage lines. Wireless signals will not penetrate metal buildings. Under most conditions, the maximum wireless range is 100' or 30m.
7. Radio Interference. Computers, radios, televisions and other sources can interfere with radio communications between the sensor array and console. Please take this into consideration when choosing console or mounting locations. Make sure your display console is at least five feet or 1.52 meter away from any electronic device to avoid interference.

### **5.3 Sensor Package Assembly**

See Figure 1 to locate and understand all the parts of the outdoor sensor package once fully assembled.

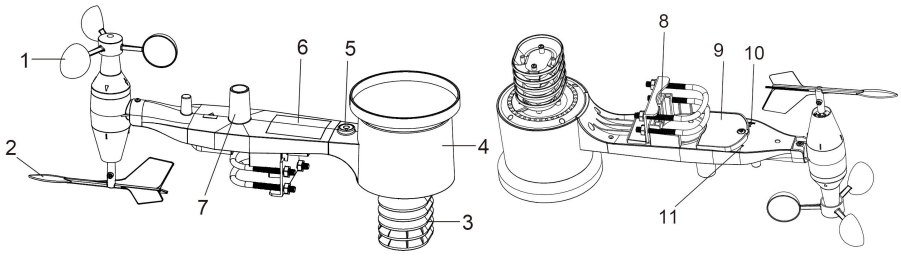

**Figure 1: Sensor assembly components**

|                                   |  |
|-----------------------------------|--|
| 1 Wind speed cups                 | 7 Light sensor and UV sensor               |
| 2 Wind vane                       | 8 U-Bolts                                  |
| 3 Thermo- and hygro-meter sensors | 9 Battery compartment door                 |
| 4 Rain collector                  | 10 Reset button                            |
| 5 Bubble level                    | 11 LED (red) to indicate data transmission |
| 6 Solar panel                     |  |

**Table 2: Sensor assembly detailed items**

### 5.3.1 Install U-bolts and metal plate

Installation of the U-bolts, which are in turn used to mount the sensor package on a pole, requires installation of an included metal plate to receive the U-bolt ends. The metal plate, visible in Figure 2 on the right side, has four holes through which the ends of the two U-Bolts will fit. The plate itself is inserted in a groove on the bottom of the unit (opposite side of solar panel). Note that one side of the plate has a straight edge (which goes into the groove), the other side is bent at a 90-degree angle and has a curved profile (which will end up “hugging” the mounting pole). Once the metal plate is inserted, remove nuts from the U-Bolts and insert both U-bolts through the respective holes of the metal plate as shown in Figure 2.

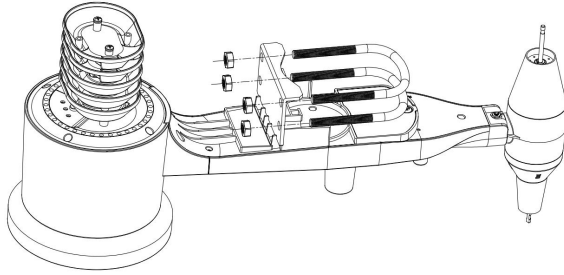

**Figure 2: U-Bolt installation**

Loosely screw on the nuts on the ends of the U-bolts. You will tighten these later during final mounting. Final assembly is shown in Figure 3.

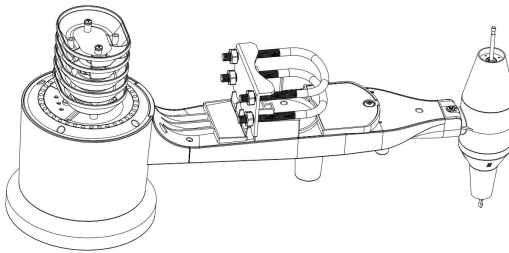

**Figure 3: U-Bolts and nuts installed**

The plate and U-Bolts are not yet needed at this stage but doing this now may help avoid damaging wind vane and wind speed cups later on. Handling of the sensor package with wind vane and speed cups installed to install these bolts is more difficult and more likely to lead to damage.

### **5.3.2 Install wind vane**

Push the wind vane onto the shaft on the bottom side of the sensor package, until it goes no further, as shown on the left side in Figure 4. Next, tighten the set screw, with a Philips screwdriver (size PH0), as shown on the right side, until the wind vane cannot be removed from the axle. Make sure the wind vane can rotate freely. The wind vane's movement has a small amount

of friction, which is helpful in providing steady wind direction measurements.

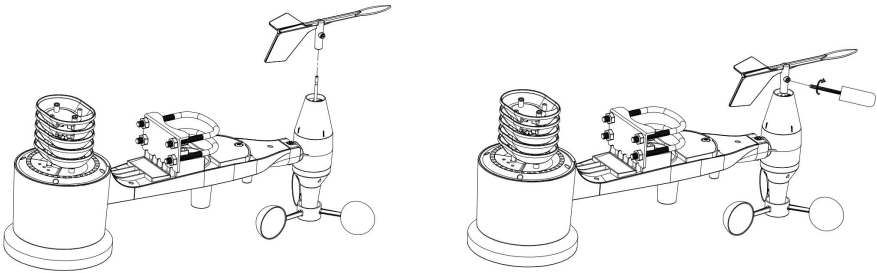

**Figure 4: Wind vane installation diagram**

### 5.3.3 Install wind speed cups

Push the wind speed cup assembly onto the shaft on the opposite side of the wind vane, as shown in Figure 5 on the left side. Tighten the set screw, with a Philips screwdriver (size PH0), as shown on the right side. Make sure the cup assembly can rotate freely. There should be no noticeable friction when it is turning.

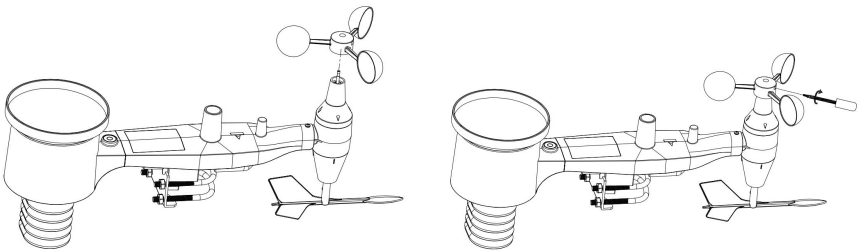
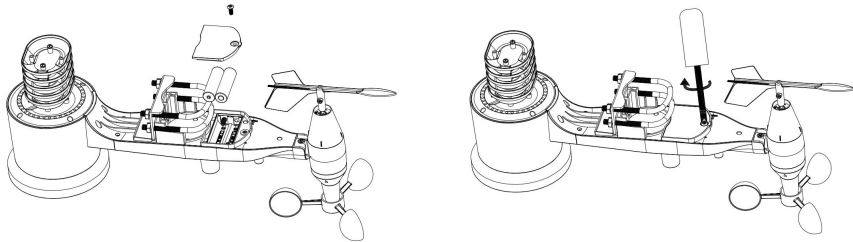

**Figure 5: Wind speed cup installation diagram**

### 5.3.4 Install Batteries in sensor package

Open the battery compartment with a screwdriver and insert 2 AA batteries in the battery compartment. The LED indicator on the back of the sensor package (item 9) will turn on for four seconds and then flash once every 16 seconds indicating sensor data transmission. If you did not pay attention, you may have missed the initial indication. You can always remove the

batteries and start over, but if you see the flash once every 16 seconds, everything should be OK.



**Figure 6: Battery installation diagram**

**Note:** If LED does not light up or is on permanently, make sure the battery is inserted the correct way and inserted fully, starting over if necessary. Do not install the batteries backwards as it may permanently damage the outdoor sensor.

**Note:** We recommend Lithium batteries for cold weather climates, but alkaline batteries are sufficient for most climates. Rechargeable batteries have lower voltages and should never be used.

### **5.3.5 Mount assembled outdoor sensor package**

#### **5.3.5.1 Before you mount**

Before proceeding with the outdoor mounting detailed in this section, you may want to skip to setup instructions in section 5.5 and onwards first, while you keep the assembled outdoor sensor package nearby (although preferably not closer than 5 ft. or 1.53m from the console). This will make any troubleshooting and adjustments easier and avoids any distance or interference related issues from the setup.

After setup is complete and everything is working, return here for outdoor mounting. If issues show up after outdoor mounting they are almost certainly related to distance, obstacles etc.

### 5.3.5.2 Mounting

You can attach a pipe to a permanent structure and then attach the sensor package to it (see Figure 7).

The U-Bolts will accommodate a pipe diameter of 1-2 inches (pipe not included).

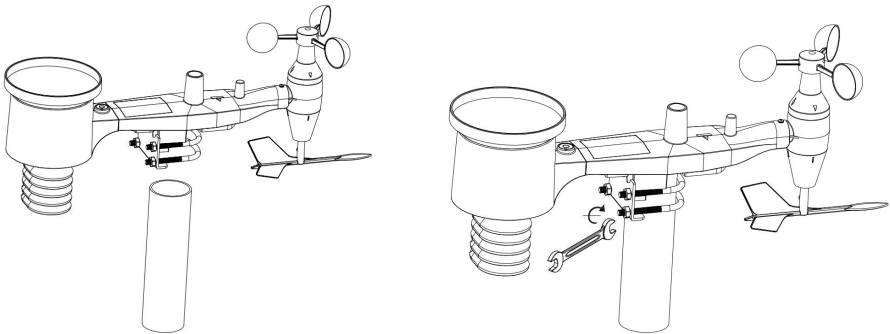

**Figure 7: Sensor package mounting diagram**

Make sure the mounting pipe is vertical, or very close to it. Use a level if needed.

Finally, place the sensor package on top of the prepared mounting pipe. The U-Bolts should be loose enough to allow this but loosen the nuts as necessary. Once placed, hand tighten all four nuts, taking care to do so evenly. Do not use a wrench yet!

Now you will need to align the whole package in the proper direction by rotating it on top of the mounting pipe as needed. Locate the arrow labeled “WEST” that you will find on top of the sensor package right next to the light sensor, on the opposite side of the solar panel. You must rotate the whole sensor package until this arrow points due west. To achieve proper alignment, it is helpful to use a compass (many cell phones have a compass application). Once rotated in the correct orientation, lightly tighten the bolts a little more (use a wrench) to prevent further rotation.



**Note:** The orientation to WEST is necessary for two reasons. The most important one is to position the solar panel and light sensor in the most advantageous position for recording solar radiation and charging internal capacitors. Secondly it causes a zero reading for wind direction to correspond to due NORTH, as is customary. This orientation is correct for installations in the northern hemisphere. If you are installing in the southern hemisphere, the correct orientation to achieve the same optimal positioning is to have the “WEST” arrow actually point due EAST! This has the side effect, however, of lining up the 0 reading of the wind direction with SOUTH. This needs to be corrected using a 180-degree offset in the calibration settings (see section 6.9.2).

Now look at the bubble level. The bubble should be fully inside the red circle. If it is not, wind direction, speed, and rain readings may not operate correctly or accurately. Adjust the mounting pipe as necessary. If the bubble is close, but not quite inside the circle, and you cannot adjust the mounting pipe, you may have to experiment with small wooden or heavy cardboard shims between the sensor package and the top of the mounting pole to achieve the desired result (this will require loosening the bolts and some experimentation).

Make sure you check, and correct if necessary, the westerly orientation as the final installation step, and now tighten the bolts with a wrench. Do not over tighten, but make sure strong wind and/or rain cannot move the sensor package.

**Note:** If you tested the full assembly indoors and then came back here for instructions and mounted to sensor package outdoor you may want to make some further adjustments on the console. The transportation from indoor to outdoor and handling of the sensor is likely to have “tripped” the rainfall sensing bucket one or more times and consequently the console may have registered rainfall that did not really exist. You can use console functions to clear this from history.

Doing so is also important to avoid false registration of these readings with weather services.

### 5.3.6 Reset Button and Transmitter LED

In the event the sensor array is not transmitting, reset the sensor array.

Using a bent-open paperclip, press and hold the **RESET BUTTON** (see Figure 8) to affect a reset: the LED turns on while the RESET button is depressed, and you can now let go. The LED should then resume as normal, flashing approximately once every 16 seconds.

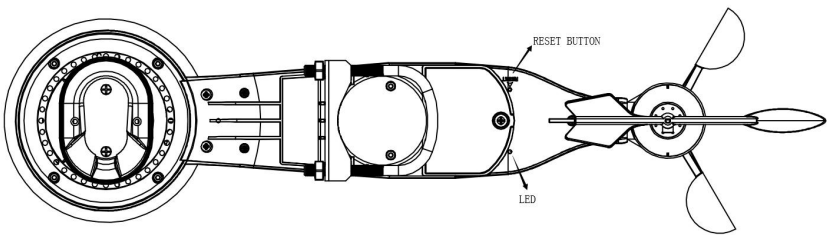

**Figure 8: Reset button and Transmitter LED location**

## 5.4 Best Practices for Wireless Communication

Wireless (RF) communication is susceptible to interference, distance, walls and metal barriers. We recommend the following best practices for trouble free wireless communication between both sensor packages and the console:

- **Electro-Magnetic Interference (EMI).** Keep the console several feet away from computer monitors and TVs.
- **Radio Frequency Interference (RFI).** If you have other devices operating on the same frequency band as your indoor and/or outdoor sensors and experience intermittent communication between sensor package and console, try turning off these other devices for troubleshooting purposes. You may need to relocate the transmitters or receivers to avoid the interference and establish reliable communication. The frequencies used by the sensors are one of (depending on your location): 433, 868, or 915 MHz (915 MHz for United States).

- **Line of Sight Rating.** This device is rated at 300 feet or 100 meter line of sight (under ideal circumstances; no interference, barriers or walls), but in most real-world scenarios, including a wall or two, you will be able to go about 100 feet or 30 meter.
- **Metal Barriers.** Radio frequency will not pass through metal barriers such as aluminum siding or metal wall framing. If you have such metal barriers and experience communication problems, you must change the placement of sensor package and or console.

The following table shows different transmission media and expected signal strength reductions. Each “wall” or obstruction decreases the transmission range by the factor shown below.

| Medium            | RF Signal Strength Reduction |
|-------------------|------------------------------|
| Glass (untreated) | 5-15%                        |
| Plastics          | 10-15%                       |
| Wood              | 10-40%                       |
| Brick             | 10-40%                       |
| Concrete          | 40-80%                       |
| Metal             | 90-100%                      |

**Table 3: RF Signal Strength reduction**

## 5.5 Display Console

The front and back of the display console is shown in Figure 9 and Figure 10.

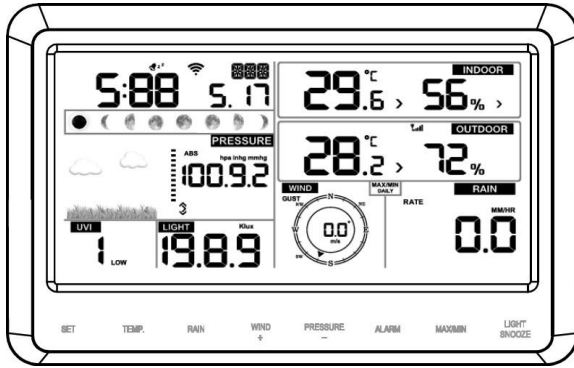

**Figure 9**

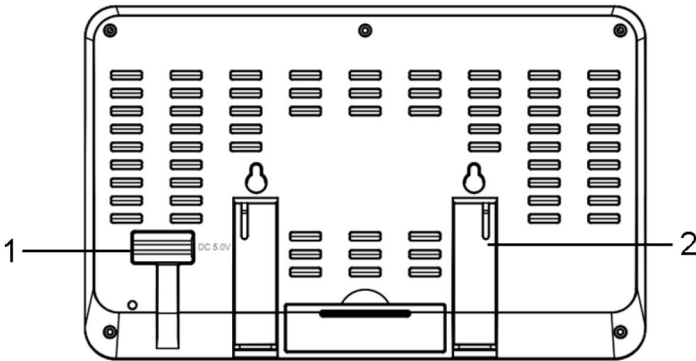

**Figure 10**

Reference Figure 10.

- (1) Connect the display console power jack to AC power adapter with the included power adapter.
- (2) Unfold the desk stand and place 5 to 10 feet or 1.5 to 3 meter away from the sensor array.

Remove the battery door on the back of the console, and insert 3xAAA batteries per Figure 11.

- (3) Wait several minutes for the remote sensors to synchronize with the display console.

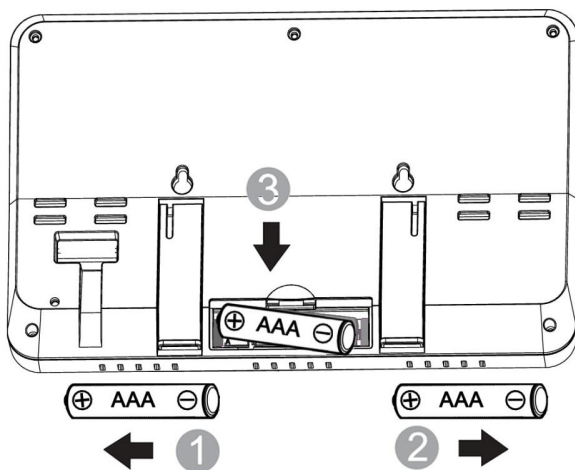
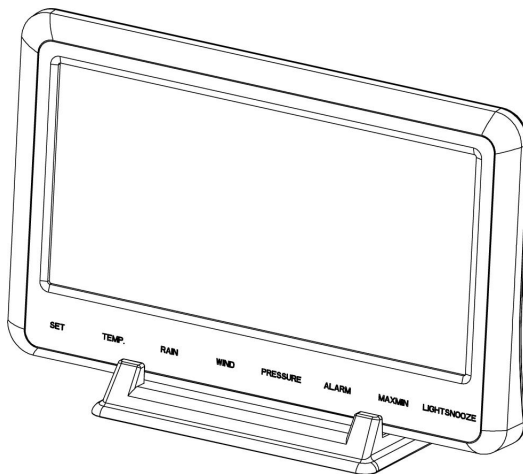

**Figure 11**

### 5.5.1 Vertical Desk Stand

The console is best viewed above from a 20 to 30 degree angle.

In addition to the fold out desk stand on the back of the display console, the console also includes a vertical desk stand to improve the viewing angle on a desk, as shown in Figure 12.

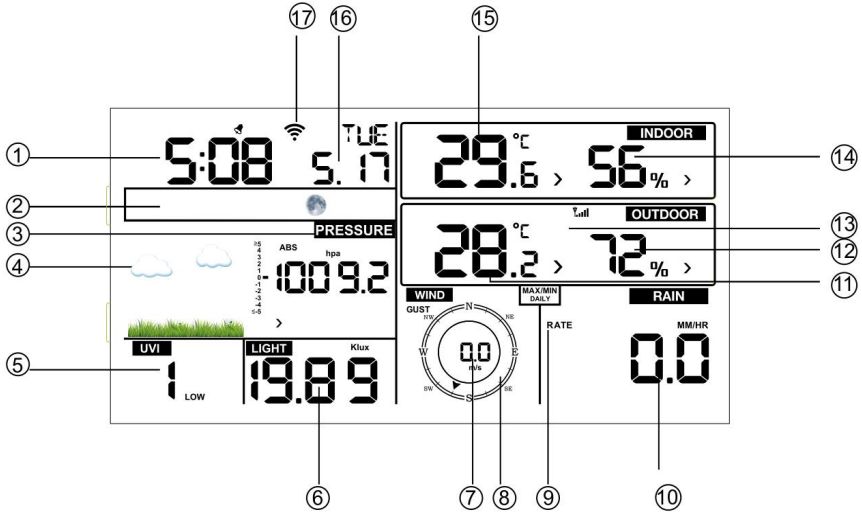

**Figure 12**

# 6 Display Console Operation

## 6.1 Screen Display

The display console home screen layout is shown in Figure 13.



**Figure 13: Display Console Screen Layout**

|                           |                         |
|---------------------------|-------------------------|
| 1. Time                   | 10. Rain fall           |
| 2. Moon phase             | 11. Outdoor temperature |
| 3. Barometric Pressure    | 12. Outdoor humidity    |
| 4. Weather forecast       | 13. RF icon             |
| 5. UV index               | 14. Indoor humidity     |
| 6. Solar Radiation(Light) | 15. Indoor temperature  |
| 7. Wind speed             | 16. Date                |
| 8. Wind direction         | 17. WIFI icon           |
| 9. MAX/MIN Daily          |                         |

**Table 4: Display console detailed items**

## 6.2 Console Initialization

After the console is connected to AC power, the console will display the software version number two seconds after power up.



Figure 14

The console will display all of the LCD segments for three seconds after power up as shown in Figure 15, the indoor conditions will immediately update, and the outdoor sensor array will register within a few minutes.

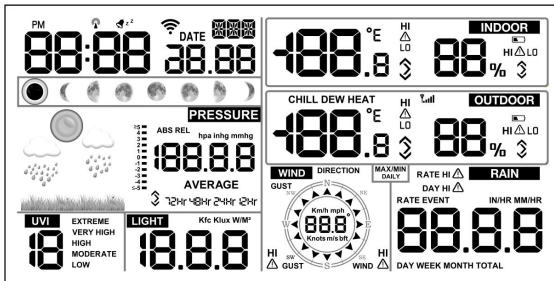

Figure 15

### 6.2.1 Button functions

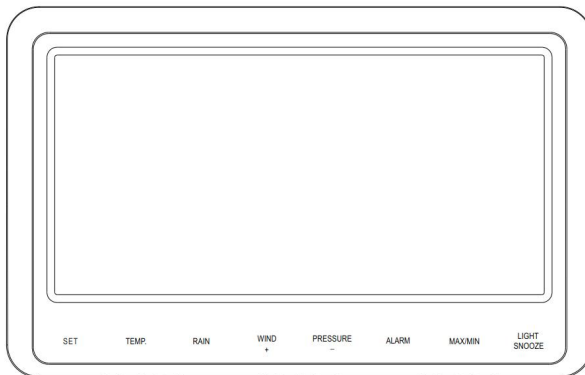

Figure 16

The console has eight buttons for easy operation:

| Button                         | Description  |
|--------------------------------|--|
| <b>SET</b>                     | Press and hold to enter the SET mode. In normal display, press this button once will display the MAC address of the device.  |
| <b>TEMP.</b>                   | <ul style="list-style-type: none"> <li>• Press to switch between Outdoor Temperature, Wind Chill, Heat Index, Dew Point.</li> <li>• To bypass RF reception, press and hold while powering up the console (connecting the AC adapter with batteries removed).</li> <li>• Hold this button for 5 seconds will re-register all the sensors</li> </ul> |
| <b>RAIN</b>                    | Press to switch between Rain Rate (in/hr), Rain Event, Rain Day, Rain Week, Rain Month, and Rain Total.  |
| <b>WIND +</b>                  | <ul style="list-style-type: none"> <li>• Press to switch between average wind speed, wind gust and wind direction.</li> <li>• While in SET mode, press to increase the value. Press and hold for two seconds to increase the value rapidly.</li> </ul>   |
| <b>PRESSURE</b><br>-           | <ul style="list-style-type: none"> <li>• Press to switch between Relative Pressure (current), and 12hr, 24hr, 48hr and 72hr average Relative Pressure.</li> <li>• While in SET mode, press to decrease the value. Press and hold for two seconds to decrease the value rapidly.</li> </ul>   |
| <b>ALARM</b>                   | Press to switch between high and low alarms  |
| <b>MAX/MIN</b>                 | Press to switch between minimum and maximum values.  |
| <b>LIGHT</b><br><b>/SNOOZE</b> | <ul style="list-style-type: none"> <li>• Press to adjust the LCD backlight brightness (high, medium and off).</li> <li>• Press to exit the SET mode at any time.</li> </ul>  |

Note:

- 1) When power on, press **WIND/+** and **PRESSURE /-** button to reset the weather station and clear all records memory, and clears all user settings to default.
- 2) The setting procedure can be exited at any time by either pressing the **LIGHT /SNOOZE** button or waiting for the 30-second time-out to take



effect.



### 6.3 Setting mode



Press and hold the **SET** button for two seconds to enter the **SET** Mode. To proceed to the next setting, press (do not hold) the **SET** button.

To exit the **SET** mode at any time, press the **LIGHT / SNOOZE** button.

Table 5 summarizes the set mode sequence and commands.

| Comm and                | Mode                              | Settings   | Image |
|-------------------------|-----------------------------------|--|-------|
| [SET]<br>+ 2<br>seconds | Enter Set Mode,<br>Beep On or Off | Press [WIND +] to switch OFF and ON.<br><br>This will prevent the beep from sounding when pressing any button.   |       |
| [SET]                   | Clear Max/Min                     | Press [WIND +] to switch OFF and ON.<br><br>When set to ON, the minimum and maximum values reset every day at midnight (00:00).<br><br>When set to OFF, the minimum and maximum values must be reset manually. |       |
| [SET]                   | 12 hour / 24 Hour<br>Format       | Press [WIND +] to switch hour format between 12 hour and 24 hour format.   |       |
| [SET]                   | Hour                              | Press [WIND +] or [PRESSURE -] to adjust hour up or down.  |       |

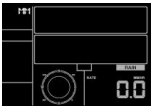
|       |                               |   |   |
|-------|-------------------------------|---|---|
| [SET] | Minute                        | Press [WIND +] or [PRESSURE -] to adjust minute up or down.   |   |
| [SET] | Date Format                   | Press [WIND +] to switch between MM-DD (month-day) and DD-MM (day-month)  |   |
| [SET] | Year                          | Press [WIND +] or [PRESSURE -] to adjust year up or down  |   |
| [SET] | Month                         | Press [WIND +] or [PRESSURE -] to adjust month up or down   |   |
| [SET] | Day                           | Press [WIND +] or [PRESSURE -] to adjust day up or down   |   |
| [SET] | Pressure Units of Measure     | Press [WIND +] to change units of measure between hPa, mmHg or inHg.  |   |
| [SET] | Relative Pressure Calibration | Press [WIND +] or [PRESSURE -] to adjust relative pressure up or down<br><br>Reference Section 6.4.4 for details on calibration of relative pressure. |   |
| [SET] | Light Units of Measure        | Press [WIND +] to change light units of measure between lux, fc, or w/m2  |  |
| [SET] | Temperature Units of Measure  | Press [WIND +] to change temperature units of measure between °F and °C.  |  |

|       |                       |   |   |
|-------|-----------------------|---|---|
| [SET] | Wind Units of Measure | Press [WIND +] to change wind units of measure between km/h, mph, knots, m/s and bft.                                       |  |
| [SET] | Rain Units of Measure | Press [WIND +] to change rain units of measure between in and mm.   |  |
| [SET] | Hemisphere            | Press [WIND +] to change hemisphere between NTH (northern) and STH (southern). This setting effects the moon phase display. |  |
| [SET] | Exit Set Mode         |   |   |

[SET] + 2 seconds means press and hold the SET button for two seconds.

[SET] means press the SET button.

Table 5: Set mode sequence and commands summarization

## 6.4 Barometric Pressure Display

### 6.4.1 Viewing Absolute vs. Relative Pressure

To switch between absolute and relative pressure, press and hold the [PRESSURE -] button for two seconds.

Absolute pressure is the measured atmospheric pressure, and is a function of altitude, and to a lesser extent, changes in weather conditions.

Absolute pressure is not corrected to sea-level conditions.

Relative pressure is corrected to sea-level conditions.

For further discussion of relative pressure and calibration, reference Section 6.4.4.

## 6.4.2 Rate of Change of Pressure Graph

The rate of change of pressure graphic is shown to the left of the barometric pressure and signifies the difference between the daily average pressure and the 30 day average (in hPa).



Figure 17

## 6.4.3 Viewing Pressure History

Press the [PRESSURE -] button to view the 12 hour, 24 hour, 48 hour and 72 hour pressure average.

## 6.4.4 Relative Pressure Calibration Discussion

To compare pressure conditions from one location to another, meteorologists correct pressure to sea-level conditions. Because the air pressure decreases as you rise in altitude, the sea-level corrected pressure (the pressure your location would be at if located at sea-level) is generally higher than your measured pressure.

Thus, your absolute pressure may read 28.62 inHg (969 mb) at an altitude of 1000 feet (305 m), but the relative pressure is 30.00 inHg (1016 mb).

The standard sea-level pressure is 29.92 inHg (1013 mb). This is the average sea-level pressure around the world. Relative pressure measurements greater than 29.92 inHg (1013 mb) are considered high pressure and relative pressure measurements less than 29.92 inHg are considered low pressure.

To determine the relative pressure for your location, locate an official reporting station near you (the internet is the best source for real time barometer conditions, such as Weather.com or Wunderground.com), and set your weather station to match the official reporting station.

## 6.5 Rain Display

### 6.5.1 Rain Increments of Measure

Press the RAIN button to switch between Rain Rate (in/hr), Rain Event, Rain Day, Rain Week, Rain Month, and Rain Total.

### 6.5.2 Resetting Rain

Display the increment of rain you wish to clear, as shown in Section 6.5.1. To reset the rain totals, press and hold the RAIN button for two seconds.

- Resetting the weekly rain also resets the daily rain.
- Resetting the monthly rain also resets the daily and weekly rain.
- Resetting the total rain also resets the monthly, weekly and daily rain.

### 6.5.3 Increments of Rain Definitions

- **Rain rate or hourly rain** is defined as the last 10 minutes of rainfall, multiplied by six (10 minutes x 6 = 1 hour). This is also referred to as instantaneous rain per hour.
- **Rain event** is defined as continuous rain, and resets to zero if rainfall accumulation is less than 10 mm (0.039 in) in a 24 hour period.
- **Daily Rain** is defined as the rainfall since midnight (00:00).
- **Weekly Rain** is defined as the calendar week total and resets on Sunday morning at midnight (Sunday thru Saturday).
- **Monthly Rain** is defined as the calendar month total and resets on the first day of the Month.
- **Total Rain** is defined as the running total since station was powered up.

## 6.6 Wind Display

Press the [WIND +] button to switch between average wind speed, wind gust and wind direction.

- Wind speed is defined as the average wind speed in the 16 second update period.
- Wind gust is defined as the peak wind speed in the 16 second update period.

## 6.7 Temperature Display

If temperature is lower than minimum range, the temperature field will display dashes (--.). If temperature is higher than maximum range, the temperature field will display dashes (--.).

### 6.7.1 Wind Chill, Dew Point and Heat Index Display

Press the [TEMP] button to switch between Outdoor Temperature, Wind Chill, Dew Point, Heat Index.

## 6.8 Alarm mode

### 6.8.1 Display of Alarm value

- 1) Press and release **ALARM** button to display high alarm



Figure 18

- 2) Press **ALARM** button again to display low alarm



**Figure 19**



Note:

- Press **RAIN** button to select display rain rate or rain daily alarm data.
- Press **WIND/+** button to select display wind or gust alarm data.
- Press **ALARM** button third time or press **LIGHT /SNOOZE** button back to normal mode

### **6.8.2 Alarm mode setting:**

- 1) Press and hold **ALARM** button for 2 seconds to enter alarm setting mode:
- 2) Press the **WIND/+** or **PRESSURE/-** to adjust alert values.
- 3) Press the **SET** button to confirm & move to the next setting.
- 4) Press the **ALARM** button to enable/disable the alarm

Note: when alert is triggered, the current triggering source  <sup>zz</sup> icon for

time, **HI**  icon for high value and **LO**  icon for low value will be flashing, indicating alert is triggered.

Note: press **ALARM** button third time back to normal mode or press **LIGHT /SNOOZE** button back to normal mode.

### **6.8.3 Alarm Setting Order:**

- 1) Time alarm setting
- 2) Indoor high temperature setting
- 3) Indoor low temperature setting
- 4) Indoor high humidity setting
- 5) Indoor low humidity setting

- 6) Outdoor high temperature setting
- 7) Outdoor low temperature setting
- 8) Outdoor high humidity setting
- 9) Outdoor low humidity setting
- 10) High wind setting
- 11) High gust setting
- 12) Rain rate high setting
- 13) Rain day high setting

## 6.9 Max/Min Mode

### 6.9.1 Viewing Max/Min Values

To view the max values, press (do not hold) the **MAX/MIN** button, and the max values will be displayed, as shown in Figure 20 (a). To clear the max values, press and hold the **MAX/MIN** button while the max values are displayed.

To view the min values, press the **MAX/MIN** button again, and the min values will be displayed, as shown in Figure 20 (b). To clear the min values, press and hold the **MAX/MIN** button while the min values are displayed.

To return to normal mode, press the **MAX/MIN** button again or press **LIGHT /SNOOZE** button.



(a)

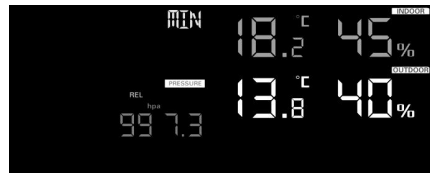

(b)

Figure 20



### **6.9.1.1 Display Wind Chill, Heat Index vs. Dew Point Max/Min Values**

While the **max values** are displayed as outlined in Section 6.9.1, press the **TEMP** button once to view the max heat index, twice to view the dew point, and a third time to return to outdoor temperature.

While the **min values** are displayed as outlined in Section 6.9.1, press the **TEMP** button once to view the min wind chill, twice to view the dew point, and a third time to return to outdoor temperature.

### **6.9.1.2 Display Wind Speed vs. Wind Gust Max Values**

While the **max values** are displayed as outlined in Section 6.9.1, press the **WIND +** button once to view the max wind gust, and twice to return to wind speed.

### **6.9.1.3 Display Rain Rate, Daily Rain, Weekly Rain and Monthly Rain Max Values**

While the **max values** are displayed as outlined in Section 6.9.1, press the **RAIN** button once to view the max daily rain, twice to view the max weekly rain, three times to view the max monthly rain, four times to return to the max rain rate.

### **6.9.1.4 Display Absolute and Relative Pressure Min and Max Values**

While the **max values** are displayed as outlined in Section 6.9.1, press and hold the **PRESSURE** button for two seconds to view the max absolute pressure, and press and hold the **PRESSURE** button for two seconds again to return to relative pressure.

While the **min values** are displayed as outlined in Section 6.9.1, press and hold the **PRESSURE** button for two seconds to view the min absolute pressure, and press and hold the **PRESSURE** button for two seconds again to return to relative pressure.

## 6.9.2 Calibration mode

Press and hold the **TEMP.** and **MAX/MIN** button together for 5 seconds to enter calibration mode. The CAL icon will be displayed.



**Figure 21**

- Press the **WIND/+** and **PRESSURE/-** button to adjust values.
- Press the **SET** button to confirm & move to the next setting.
- Press the **ALARM** button to reset any adjusted value.
- Press the **LIGHT /SNOOZE** button at any time to exit.

### 6.9.2.1 Calibration Order:

- 1) Indoor temperature offset calibrated (range +/-5°C, default: 0 degrees)
- 2) Indoor humidity offset calibrated (range +/-10%)
- 3) Outdoor temperature offset calibrated (range +/-5°C, default: 0 degrees)
- 4) Outdoor humidity offset calibrated (range +/-10%)
- 5) Absolute pressure offset calibrated ( $\pm 10$  hPa ( $\pm 2.95$  inHg))
- 6) Wind direction offset calibrated ( $\pm 180^\circ$ )
- 7) Wind speed factor adjust, default 1 (range 0.5 to 1.5)
- 8) Rain factor adjust, default 1 (range 0.5 to 1.5)

## 6.9.3 Calibration Discussion

The purpose of calibration is to fine tune or correct for any sensor error associated with the devices margin of error. Errors can occur due to electronic variation (example, the temperature sensor is a resistive thermal device or RTD, the humidity sensor is a capacitance device), mechanical variation, or degradation (wearing of moving parts, contamination of sensors).

Calibration is only useful if you have a known calibrated source you can compare it against, and is optional. This section discusses practices, procedures and sources for sensor calibration to reduce manufacturing and degradation errors. Do not compare your readings obtained from sources such as the internet, radio, television or newspapers. The purpose of your weather station is to measure conditions of your surroundings, which vary significantly from location to location.

| <b>Parameter</b> | <b>Type of Calibration</b> | <b>Default</b> | <b>Typical Calibration Source</b>                                  |
|------------------|----------------------------|----------------|--|
| Temperature      | Offset                     | Current Value  | Red Spirit or Mercury Thermometer (1)                              |
| Humidity         | Offset                     | Current Value  | Sling Psychrometer (2)   |
| ABS Barometer    | Offset                     | Current Value  | Calibrated laboratory grade barometer                              |
| REL Barometer    | Offset                     | Current Value  | Local airport (3)  |
| Wind Direction   | Offset                     | Current Value  | GPS, Compass (4)   |
| Wind             | Gain                       | 1.00           | Calibrated laboratory grade wind meter (5)                         |
| Rain             | Gain                       | 1.00           | Sight glass rain gauge with an aperture of at least 4" or 0.1m (6) |

**Table 6: Calibration parameter summarization**

(1) Temperature errors can occur when a sensor is placed too close to a heat source (such as a building structure, the ground or trees).

To calibrate temperature, we recommend a mercury or red spirit (fluid) thermometer. Bi-metal (dial) and digital thermometers (from other weather

stations) are not a good source and have their own margin of error. Using a local weather station in your area is also a poor source due to changes in location, timing (airport weather stations are only updated once per hour).

Place the sensor in a shaded, controlled environment next to the fluid thermometer, and allow the sensor to stabilize for 48 hours. Compare this temperature to the fluid thermometer and adjust the console to match the fluid thermometer.

(2) Humidity is a difficult parameter to measure electronically and drifts over time due to contamination. In addition, location has an adverse effect on humidity readings (installation over dirt vs. lawn for example).

Official stations recalibrate or replace humidity sensors on a yearly basis. Due to manufacturing tolerances, the humidity is accurate to  $\pm 5\%$ . To improve this accuracy, the indoor and outdoor humidity can be calibrated using an accurate source, such as a sling psychrometer.

(3) The display console displays two different pressures: absolute (measured) and relative (corrected to sea-level).

To compare pressure conditions from one location to another, meteorologists correct pressure to sea-level conditions. Because the air pressure decreases as you rise in altitude, the sea-level corrected pressure (the pressure your location would be at if located at sea-level) is generally higher than your measured pressure.

Thus, your absolute pressure may read 28.62 inHg (969 mb) at an altitude of 1000 feet (305 m), but the relative pressure is 30.00 inHg (1016 mb).

The standard sea-level pressure is 29.92 in Hg (1013 mb). This is the average sea-level pressure around the world. Relative pressure measurements greater than 29.92 inHg (1013 mb) are considered high

pressure and relative pressure measurements less than 29.92 inHg are considered low pressure.

To determine the relative pressure for your location, locate an official reporting station near you (the internet is the best source for real time barometer conditions, such as Weather.gov, Weather.com or Wunderground.com), and set your weather station to match the official reporting station.

(4) Only use this if you improperly installed the weather station sensor array, and did not point the direction reference to true north.

(5) Wind speed is the most sensitive to installation constraints. The rule of thumb for properly installing a wind speed sensor is 4 x the distance of the tallest obstruction. For example, if your house is 20' or 6.10m tall and you mount the sensor on a 5' or 1.52m pole:

$$\text{Distance} = 4 \times (20 - 5)' = 60' \text{ or } = 4 \times (6.10 - 1.52) = 18.32\text{m}.$$

Many installations are not perfect and installing the weather station on a roof can be difficult. Thus, you can calibrate for this error with a wind speed multiplier.

In addition to the installation challenges, wind cup bearings (moving parts) wear over time.

Without a calibrated source, wind speed can be difficult to measure. We recommend using a calibrated wind meter (not included) and a constant speed, high speed fan.

Note: If located in southern hemisphere, please follow the steps to calibrate the wind direction:

1. Install the outdoor sensor package with the West arrow on the sensor pointing due East.

2. Check the wind direction offset (Default: equals to the current wind direction )

If:

Current wind direction offset  $< 180$ , then it should be calibrated to be: current wind direction + 180

If:

Current wind direction offset  $> 180$ , then it should be calibrated to be: current wind direction - 180

For example, if the current wind direction is 288, then you'll need to set the wind direction offset to be:  $288-180=108$ .

If the current wind direction is 12, then you'll need to set the wind direction offset to be:  $12+180=192$ .

(6) The rain collector is calibrated at the factory based on the funnel diameter. The bucket tips every 0.01" or 0.1m of rain (referred to as resolution). The accumulated rainfall can be compared to a sight glass rain gauge with an aperture of at least 4" or 0.1m.

Make sure you periodically clean the rain gauge funnel.

If there's any question, please contact us at [support@ecowitt.com](mailto:support@ecowitt.com) or [support.eu@ecowitt.net](mailto:support.eu@ecowitt.net) (EU/UK).

## 6.10 Other Features

### 6.10.1 Factory Reset/Clear Memory

To restore the console to factory default, perform the following steps:

1. Remove the power from the console by removing the batteries and disconnecting the AC adapter.
2. Apply power by connecting the AC adapter.
3. Wait for all of the segments to appear on the screen,.
4. Press and hold the **WIND/+** and **PRESSURE/-** buttons at the same time until the console power up sequence is complete (about 5 seconds).

5. Replace the batteries.

## 6.11 Resynchronize Wireless Sensor

Press and hold the **LIGHT /SNOOZE** button for 5 seconds, and the console will re-register the wireless sensor.

## 6.12 Backlight Operation

- 1) With AC adaptor.

The backlight can only be continuously on when the AC adapter is permanently on. When the AC adapter is disconnected, the backlight can be temporarily turned on.

Press the **LIGHT SNOOZE** button to adjust the brightness between High, Low and Off.

- 2) Without AC adaptor



To reduce power consumption, the display console will automatically enter sleep mode and will not send data to the Internet .

To temporarily turn on the back light for 15 seconds, press the **LIGHT SNOOZE** button.

### 6.12.1 Tendency indicators

Tendency arrows allow you to quickly determine of temperature or pressure are rising and falling in a three hour update period, updated every 30 minutes.

Table 7 defines the conditions for rising and falling pressure every 3 hours.

| Tendency indicators   | Condition | Humidity Change per 3 Hours | Temperature Change per 3 Hours | Pressure Change per 3 Hours |
|---|-----------|-----------------------------|--------------------------------|-----------------------------|
|  | Rising    | Rising > 3%                 | Rising >= 1C/2F                | Rising > 1hpa               |
|  | Steady    | Change <=                   | Change < 1C/2F                 | Change <=                   |

|   |         |              |                  |                |
|---|---------|--------------|------------------|----------------|
|   |         | 3%           |                  | 1hpa           |
|  | Falling | Falling > 3% | Falling >= 1C/2F | Falling > 1hpa |

**Table 7: Tendency indicators summarization**

### 6.12.2 Wireless Signal Strength Indicator

The wireless signal strength displays reception quality. If no signal is lost, the signal strength indicator will display 5 bars. If the signal is lost once, four bars will be displayed, as show in Figure 22.

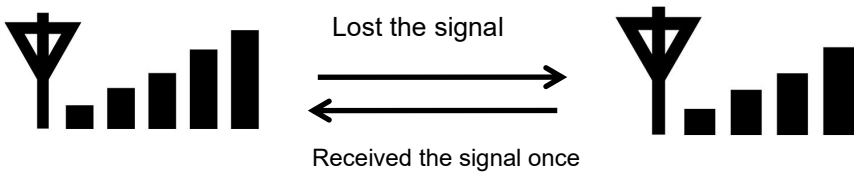







**Figure 22**

### 6.12.3 Weather Forecasting

The six weather icons are Sunny, Partly Cloudy, Cloudy, Rainy, Stormy and Snowy.

The forecast icon is based on the rate of change of barometric pressure. Please allow at least **one month** for the weather station to learn the barometric pressure over time.

| Sunny   | Partly Cloudy   | Cloudy  | Rainy   | Stormy  | Snowy   |
|---|---|---|---|---|---|
|  |  |  |  |  |  |
| Pressure increases for a sustained period of time                                   | Pressure increases slightly   | Pressure decreases slightly   | Pressure decreases for a sustained period of time                                   | Pressure rapidly decreases  | Pressure decreases for a sustained period of time and temperature is below freezing |



### **Table 8: Weather forecasting summarization**

Note: Snowy icon will appear in place of rainy icon when the outdoor temperature is below 0°C (32 F).

#### **6.12.4 Storm Alert**

If there is a rapid drop in barometric pressure, the forecast icon will flash.

#### **6.12.5 Weather Forecasting Description and Limitations**

In general, if the rate of change of pressure increases, the weather is generally improving (sunny to partly cloudy). If the rate of change of pressure decreases, the weather is generally degrading (cloudy, rainy or stormy). If the rate of change is relatively steady, it will read partly cloudy.

The reason the current conditions do not match the forecast icon is because the forecast is a prediction 24-48 hours in advance. In most locations, this prediction is only 70% accurate and it is a good idea to consult the National Weather Service for more accurate weather forecasts. In some locations, this prediction may be less or more accurate. However, it is still an interesting educational tool for learning why the weather changes.

The National Weather Service (and other weather services such as Accuweather and The Weather Channel) have many tools at their disposal to predict weather conditions, including weather radar, weather models, and detailed mapping of ground conditions.

#### **6.12.6 Snooze**

When time alarm has been triggered, the alarm will sound and the alarm icon will flash for 120s. Press **SNOOZE/LIGHT** button to silence the alarm for 10 minutes and then the alarm will sound again when that time is up. Press any button except **SNOOZE/LIGHT** button to stop the alarm.

## 7 Publishing to Internet Weather Services

Your console is capable of sending your sensor data to select internet-based weather services. The supported services are shown in the table below:

| Service             | Website   | Description  |
|---------------------|---|--|
| Ecowitt Weather     | <a href="https://www.ecowitt.net">https://www.ecowitt.net</a>           | Ecowitt is a new weather server that can host a bunch of sensors that other services don't support.  |
| Weather Underground | <a href="https://www.wunderground.com">https://www.wunderground.com</a> | Weather Underground is a free weather hosting service that allows you to send and view your weather station data real-time, view graphs and gauges, import text data for more detailed analysis and use iPhone, iPad and Android applications available at Wunderground.com. Weather Underground is a subsidiary of The Weather Channel and IBM. |
| WOW                 | <a href="http://wow.metoffice.gov.uk/">http://wow.metoffice.gov.uk/</a> | WOW is a UK based weather observation website.   |
| Weather Cloud       | <a href="https://weathercloud.net">https://weathercloud.net</a>         | Weathercloud is a real-time weather social network formed by observers from around the world.  |
| Customized Website  |   | Supports uploading to your customized website, if the website has the same protocol with Wunderground or Ecowitt   |

**Table 9: Supported weather services**

## 7.1 Connecting the Weather Station Console to Wi-Fi

To send weather data to these services you must connect your console to the internet via Wi-Fi. The console can only operate using Wi-Fi when the external power adapter is connected and plugged in!

**Note:** If you are testing the setup with the outdoor sensor package nearby and indoor, you may want to consider connecting to Wi-Fi, but not yet configuring any of the weather services. The reason is that while indoor the temperatures and humidity recorded by the outdoor sensor, and as reported to the weather service(s) will reflect indoor conditions, and not outdoor conditions. Therefore, they will be incorrect. Furthermore, the rainfall bucket may be tripped during handling, causing rain to register while it may not actually have been raining. One way to prevent this is to follow all instructions, except to use an incorrect password, on purpose! Then, after final outdoor installation, come back and change the password after clearing console history. That will start uploading to the services with a clean slate.

### 7.1.1 Configure Device – Connect your console with WIFI

The console can function as an independent Wi-Fi access point during Wi-Fi configuration. This will be used to allow your mobile application to connect to it directly during configuration (temporarily), passing configuration information about your normal Wi-Fi network to the console so that it can later connect to your preferred Wi-Fi network.

Please follow the following procedure:

1. Download the mobile application (WS View Plus) from the iOS App Store or Google Play store, as appropriate for your device.
2. Power your console with the included AC adapter and ensure it is in Wi-Fi configuration mode (Wi-Fi icon and M-B flashing). If it is not, follow the procedure to put it in that mode (hold down WIND + PRESSURE buttons for about 5 seconds).

3. Start the application and make sure the location permission function is granted (on) when you are running the app for the first time. In case you disabled the location access function for this application, please go to your mobile device settings page and configure it as “on”. The application needs your location to configure weather services.
4. Press “Configure New Device”. This may be automatic on the very first use of the application.
5. Tap on the appropriate device type and select “Next”. Follow the prompts.

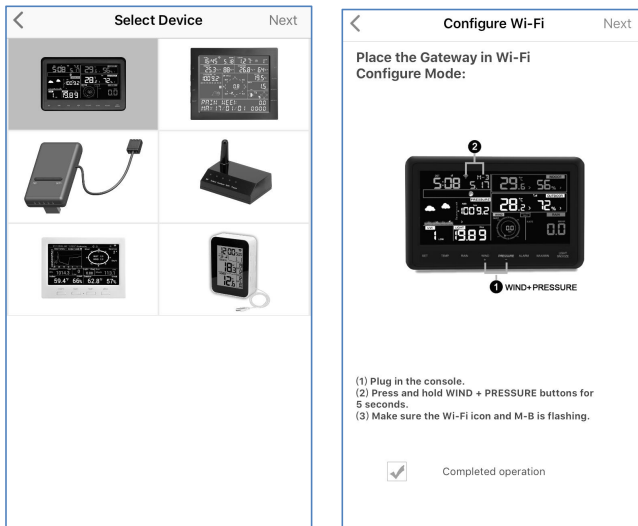

**Figure 23**

6. Confirm Wi-Fi configuration mode is active, as prompted. Correct if necessary (see above). Press “Next”.
7. **For Android version:**  
Enter your preferred Wi-Fi SSID (network name) and security password. You can set the uploading to weather servers (Ecowitt Weather / Weather Underground / Weather Cloud / WOW / Customized Website) on this page or do that after the Wi-Fi configuration done.

Scroll to the bottom of the screen and press “Save”. This will be communicated to the console in a later step.

**For iOS version:**

Switch your mobile device to the ad-hoc Wi-Fi network created by your console. It will be named something like “EasyWeather-WIFI” followed by some numbers. Wait until connected. You may see a message such as “Unsecured Network” and “No Internet connection”: this is normal and can be ignored.

Return to the mobile application. Enter your preferred Wi-Fi SSID (network name) and security password. You can set the uploading to weather servers (Ecowitt Weather / Weather Underground / Weather Cloud / WOW / Customized Website) on this page or do that after the Wi-Fi configuration done.

Press “Next”. This will be communicated to the console in a later step.

8. The connection should be recognized, and you should see a few messages about connecting to the gateway and configuring it. The RED LED on the gateway should now no longer be flashing red.
9. Your mobile device should have been returned to your normal Wi-Fi network setting and the page will automatically jump to Upload page.

If not successfully, please contact the customer service resolve the issue.

## **7.2 Adding and weather services**

You may have configured weather services during the initial configuration, or you may do so later. To do so, open the mobile application and select your device from the device list. This will bring you to the “Upload” screen for the device.

Navigate to the weather service you wish to configure by pressing “Next” and enter the appropriate data.

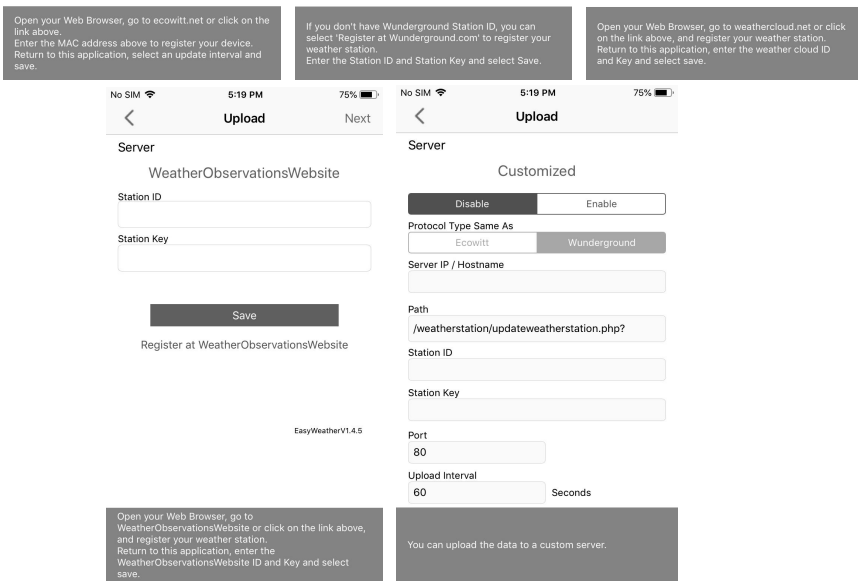
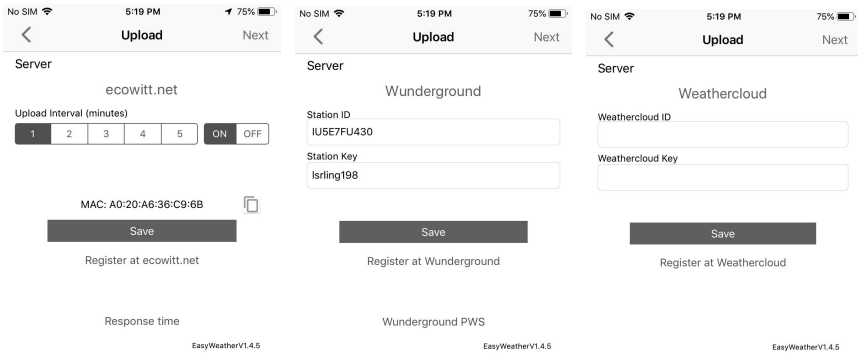

Figure 24

## 7.2.1 Ecovitt Weather

It's recommended to use the Ecovitt Weather server to monitor and record your sensors' data. Configure as follows:

- On the ecowitt.net uploading page, enable the ON button (displayed blue) and set the uploading interval time.
- Press Save on the page.
- Press “Register at ecowitt.net” and finish the registration on the page.

- Press the “+” button and select enter your email address.
- Set a password for your ecowitt account
- Press Submit.
- Enter the captcha you received from your email box and press submit.

- It will jump to the ecowitt.net dashboard and display the sensor data within several minutes.

**Note:**

If you could not receive the captcha from your email box, please check the spam.

It only supports setting the units and language on the WS View Plus app. To use the full settings, please visit the ecowitt website on your browser or on a computer.

If you could not register on the WS View Plus app, please go to the website to register and add the device.

## 7.2.2 Viewing data on ecowitt.net

You can observe your sensor's data by using the ecowitt.net web site. You will use a URL like this one, where your station ID replaces the text "STATIONID".

<https://www.ecowitt.net/home/index?id=STATIONID>

Note: If you want to share your station data with other users, you may use the Share option under the Menu to create a share link.

It will show a page such as this, where you can look at today's data and historical data as well.

### Dashboard



### Graph display





## List display

6:37 PM Thu Aug 22

The table displays weather data for August 22, 2019, with columns for Time, Temperature (°C), Humidity(%), Dew Point(°C), Feels Like(°C), Absolute(hPa), Relative(hPa), Wind Speed(m/s), Wind Gust(m/s), and Wind Dir. The data shows a typical diurnal cycle with temperature peaking at 32.7°C and humidity fluctuating between 72% and 77%.

| Time             | Temperature (°C) | Humidity(%) | Dew Point(°C) | Feels Like(°C) | Temperature (°C) | Humidity(%) | Absolute(hPa) | Relative(hPa) | Wind Speed(m/s) | Wind Gust(m/s) | Wind Dir |
|------------------|------------------|-------------|---------------|----------------|------------------|-------------|---------------|---------------|-----------------|----------------|----------|
| 2019-08-22 18:30 | 31.3             | 77          | 26.8          | 40.9           | 31.8             | 72          | 997.8         | 997.8         | 1.0             | 2.0            | 4        |
| 2019-08-22 18:25 | 31.5             | 77          | 26.9          | 41.3           | 31.8             | 71          | 997.7         | 997.7         | 1.1             | 1.5            | 2        |
| 2019-08-22 18:20 | 31.5             | 76          | 26.8          | 41.2           | 31.9             | 71          | 997.8         | 997.8         | 0.8             | 1.5            | 3        |
| 2019-08-22 18:15 | 31.6             | 76          | 26.9          | 41.4           | 32.0             | 71          | 997.7         | 997.7         | 0.9             | 2.0            | 2        |
| 2019-08-22 18:10 | 31.7             | 75          | 26.8          | 41.5           | 32.0             | 71          | 997.6         | 997.6         | 0.7             | 2.0            | 3        |
| 2019-08-22 18:05 | 31.8             | 75          | 26.8          | 41.6           | 32.0             | 71          | 997.6         | 997.6         | 0.8             | 2.6            | 2        |
| 2019-08-22 18:00 | 31.9             | 74          | 26.7          | 41.6           | 32.1             | 71          | 997.5         | 997.5         | 1.1             | 3.1            | 8        |
| 2019-08-22 17:55 | 31.9             | 75          | 26.9          | 41.9           | 32.0             | 70          | 997.5         | 997.5         | 1.1             | 3.6            | 7        |
| 2019-08-22 17:50 | 32.1             | 74          | 26.9          | 42.4           | 32.1             | 70          | 997.4         | 997.4         | 1.0             | 2.0            | 5        |
| 2019-08-22 17:45 | 32.2             | 74          | 27.0          | 42.6           | 32.1             | 70          | 997.4         | 997.4         | 1.7             | 2.6            | 1        |
| 2019-08-22 17:40 | 32.3             | 74          | 27.1          | 42.9           | 32.2             | 70          | 997.1         | 997.1         | 0.6             | 2.0            | 2        |
| 2019-08-22 17:35 | 32.5             | 73          | 27.0          | 43.1           | 32.2             | 69          | 997.3         | 997.3         | 0.9             | 2.6            | 6        |
| 2019-08-22 17:30 | 32.7             | 72          | 27.1          | 43.6           | 32.2             | 69          | 997.4         | 997.4         | 0.5             | 1.5            | 5        |

## Weather Map

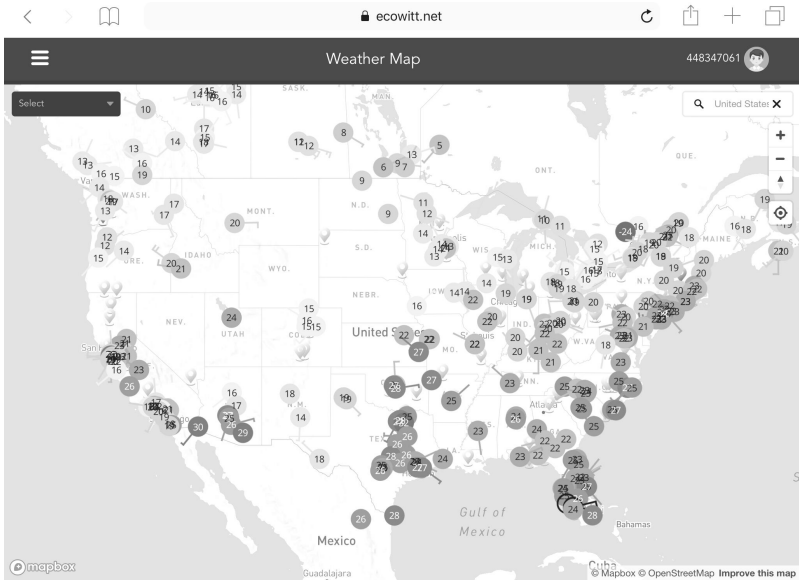

## Email Alerts

The screenshot shows the 'Alerts' settings page in the Ecowitt app. The page is titled 'Alerts' and shows the user's name 'luna' and ID '867941883'. The alert settings are configured for 'Indoor: Temperature' with a threshold of 'is less than' and a temperature value of 30.0°C. The alert history shows multiple alerts triggered on 2019-09-05 at various times, all with the same message: 'You have an Ecowitt Weather Alert: Temperature at luna is 30.0°C. Notice: Today's email alerts service has reached its upper limit! The service will be automatically restored the day after.'

| Alert History       | Alert Message   |
|---------------------|---|
| 2019-09-05 18:16:08 | You have an Ecowitt Weather Alert: Temperature at luna is 30.0°C. Notice: Today's email alerts service has reached its upper limit! The service will be automatically restored the day after. |
| 18:11:03            | You have an Ecowitt Weather Alert: Temperature at luna is 30.5°C. Notice: Today's email alerts service has reached its upper limit! The service will be automatically restored the day after. |
| 18:05:58            | You have an Ecowitt Weather Alert: Temperature at luna is 30.7°C. Notice: Today's email alerts service has reached its upper limit! The service will be automatically restored the day after. |
| 18:00:53            | You have an Ecowitt Weather Alert: Temperature at luna is 30.7°C. Notice: Today's email alerts service has reached its upper limit! The service will be automatically restored the day after. |
| 17:55:48            | You have an Ecowitt Weather Alert: Temperature at luna is 30.7°C. Notice: Today's email alerts service has reached its upper limit! The service will be automatically restored the day after. |
| 17:50:43            | You have an Ecowitt Weather Alert: Temperature at luna is 30.0°C. Notice: Today's email alerts service has reached its upper limit! The service will be automatically restored the day after. |
| 17:45:38            | You have an Ecowitt Weather Alert: Temperature at luna is 30.0°C. Notice: Today's email alerts service has reached its upper limit! The service will be automatically restored the day after. |
| 17:40:33            | You have an Ecowitt Weather Alert: Temperature at luna is 30.0°C. Notice: Today's email alerts service has reached its upper limit! The service will be automatically restored the day after. |

## 7.3 Weather Underground

If you are planning to use wunderground.com you must have an account and register a (new) personal weather station. You may do so on the Wunderground uploading page in the WS View Plus application:

- Press Register at Wunderground.com and finish the registration on the page:
  1. Visit Wunderground.com and click **Join** as the right top arrow indicates and select the **Sign up for free** option.



### Join Weather Underground

- Choose real-time alerts for your city.
- Choose adding your webcam or personal weather station.
- You can delete your account at any time from your member settings.

The Weather Company needs your email to create your Weather Underground account.

Email

Password (5-30 characters)  [Show](#)

Confirm New Password:

I agree to the [Terms of Use](#)

[Sign up for free](#)

Already have an account? [Sign in](#)

2. Click **My Profile** and select **My Devices** to register your station

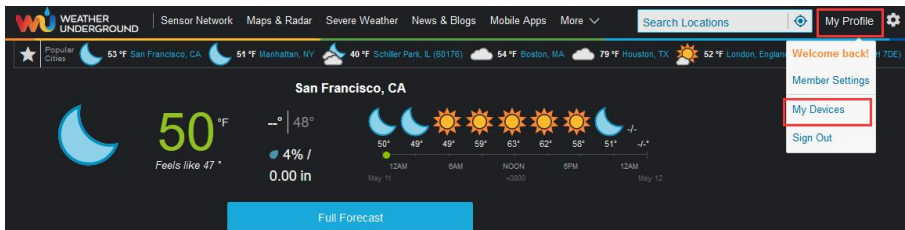

### 3. Select Add New Device.

WEATHER UNDERGROUND | Sensor Network | Maps & Radar | Severe Weather | News & Blogs | Mobile Apps | More

Search Locations | My Profile

Popular Cities: San Francisco, CA (53°F Clear), Manhattan, NY (51°F Clear), Schiller Park, IL (60176) (40°F Mostly Cloudy), Boston, MA (54°F Cloudy), Houston, TX (79°F Cloudy), London, England, United Kingdom (WC2H TDE) (52°F Partly Cloudy)

## Member Settings

EMAIL & PASSWORD | HOME & FAVORITES | **MY DEVICES** | API KEYS

### Manage Devices

0 DEVICES TOTAL

**Add New Device**

No devices to show  
Weather Underground is a global community of people connecting data from

### 4. Find Personal Weather Station. Select 'other' and click 'Next'.

## Add a New Device

TYPE | LOCATION | DETAILS | DONE

### Select a Device Type

25%

#### Personal Weather Station

other (selected) **Next**

- RainWise MK-III-LR
- RainWise AgroMET
- Raspberry Pi
- Texas Instruments WR-25-C
- Texas Instruments WLS-8000
- Texas Instruments WPS
- Texas Instruments WRS-Standard
- Texas Instruments WRS-Solar
- TML208
- Tycon Power Systems ProWeatherStation
- WeatherFlow
- WeatherHawk 611
- WeatherHawk 610
- WeatherHawk 620
- WeatherHawk 621
- WeatherHawk 232
- WeatherHawk 916
- WeatherHawk 922
- WeatherHawk 240
- other**

#### Outdoor Webcam

Select camera type **Next**

Terms of Use | Privacy Policy | AdChoices | Data Vendors

Technology for good. Take control of your data.

Data Rights

the IBM Cloud

WU

Technology LLC 2014 - 2021

### 5. Select 'Address' or 'Manual' option, and find your local position. Press 'Next'.

## Add a New PWS

TYPE LOCATION DETAILS DONE

### Set Device Name & Location

50%

#### Device Location:

Address  Manual

48.101,11.363

Your Location has been verified and added!

Elevation: 1841 ft  
Lat. Lon: 48.101, 11.363  
Neighborhood: Krallring  
Time Zone: Europe/Berlin

Back

Next



- This time you will be asked details about your weather station. Go ahead and fill out the form.

## Add a New PWS

TYPE LOCATION DETAILS DONE

### Tell Us More About Your Device

75%

Name:(Required)

Give Your Device a Name

Surface Type:

Elevation:(Required)

89

Associate Webcam:

Select WebCams

Device Hardware:(Required)

other

Height Above Ground:

Ft. Above Ground

#### You Make Our Forecasts More Accurate, We Respect Your Privacy

Contribute to the Weather Underground community by sharing some information about yourself and your sensor. We use this information to manage your account and to improve the experience from the Weather Underground community. We may also share certain data for commercial purposes, such as your sensor location.

[Learn more about how we take your privacy seriously](#)

(Required)

I Accept  I Deny

Email Preferences:

I would like to receive PWS notifications.

Back

Next

- After completing the weather station, you will see station ID and key/password.

## Add a New PWS

TYPE

LOCATION

DETAILS

**DONE**

Registration Complete!

100%

Congratulations! Your personal weather station is now registered with Weather Underground.

Enter the information below to your weather station software.

Your PWS  
Station ID:   
Station Key:   
[Copy credentials](#)



- Take note of the PWS identifier (ID) and the password that will be generated for you.
- Back to the app and input the Station ID and Key.
- Press Save.
- Back to the Menu page and select WU Dashboard(for Android version) or select your station on the Stations(for iOS version) . You'll see the current WU data, including graphs on the screen within hours.

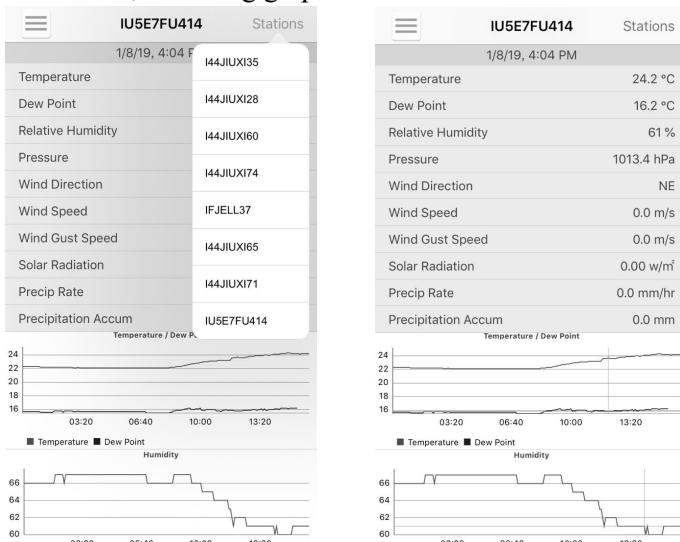

Figure 25

Note: **WU Dashboard** shows the data obtained from WU server. This requires that your mobile device can reach the Internet and therefore this is possible even when you are not on your home Wi-Fi network, such as when using cellular data.

## 7.4 Viewing data on wunderground.com

You can also observe your weather station’s data by using the wunderground.com web site. You will use a URL like this one, where your station ID replaces the text “STATIONID”.

<http://www.wunderground.com/personal-weather-station/dashboard?ID=STATIONID>

It will show a page such as this, where you can look at today’s data and historical data as well.

**Darwin (+9:30 Zone) Test Station IDARWIN13** About this PWS Report Comments

Forecast for Darwin, AU > -12.460 130.841 > 66 ft

PWS Data PWS Widgets WunderStation My PWS

PWS viewed 3 times since July 3, 2018

Satellite Webcam Icon

Mapbox © Mapbox © OpenStreetMap | Improve this map

View WunderMap

Weather History for Darwin, [IDARWIN13]

Summary July 6, 2018

|               | High    | Low     | Average |                | High     | Low      | Average |
|---------------|---------|---------|---------|----------------|----------|----------|---------|
| Temperature   | 82.4 °F | 77.4 °F | 79.9 °F | Wind Speed     | 13 mph   | --       | 12 mph  |
| Dew Point     | 73.8 °F | 64.6 °F | 70.1 °F | Wind Gust      | 14 mph   | --       | --      |
| Humidity      | 79%     | 63%     | 70%     | Wind Direction | --       | --       | West    |
| Precipitation | 0 in    | --      | --      | Pressure       | 29.67 in | 29.59 in | --      |

There are also some very useful mobile apps. The URLs provided here go to the Web version of the application pages. You can also find them directly from the iOS or Google Play stores:

**WunderStation:** iPad application for viewing your station’s data and graphs:

<https://itunes.apple.com/us/app/wunderstation-weather-from-your-neighborhood/id906099986>

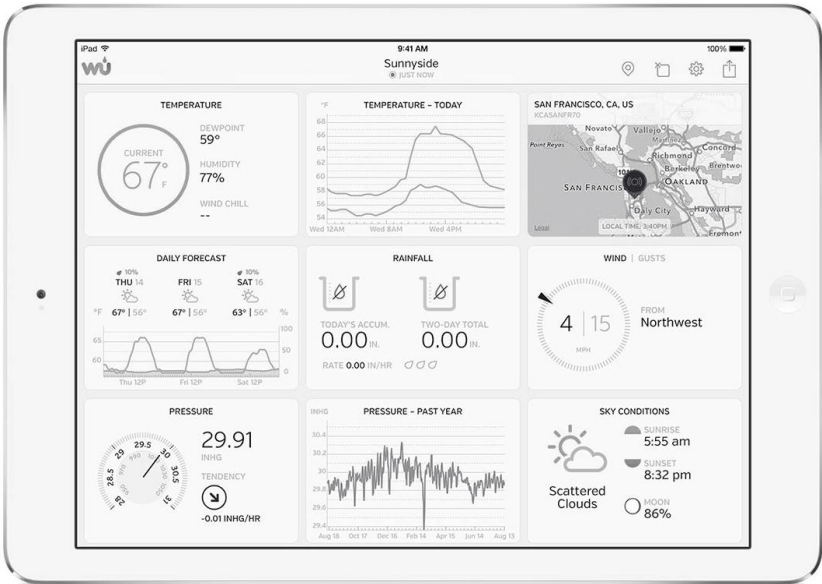

**Weather Underground: Forecast:** iOS and Android application for forecasts

<https://itunes.apple.com/us/app/weather-underground-forecast/id486154808>

<https://play.google.com/store/apps/details?id=com.wunderground.android.weather&hl=en>



Current conditions at a glance



Geek out on data



Interactive radar and satellite



**PWS Weather Station Monitor:** View weather conditions in your neighborhood, or even right in your own backyard. Connects to wunderground.com:

<https://itunes.apple.com/us/app/pws-weather-station-monitor/id713705929>

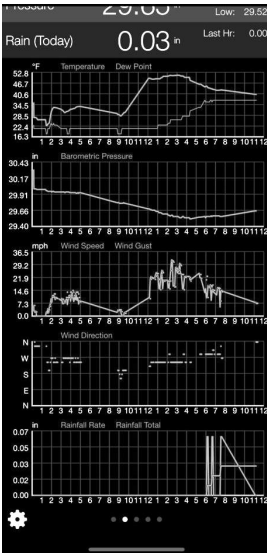

## 7.5 Device list

When on WU Dashboard screen, you can press the “Menu” button (upper right) and select Device List to view all your devices.

You can press your device to view or modify the settings.

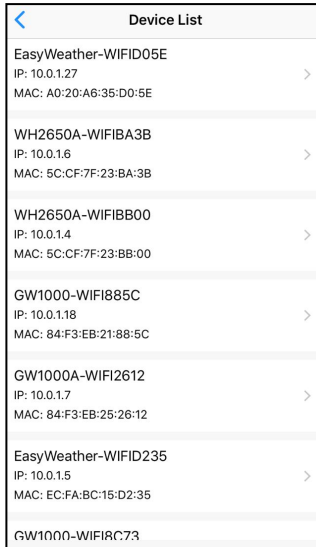

**Figure 26**

Note: This function requires that your phone and the console is using the same network.

## 7.6 Manage Wunderground

You can add or delete WU Station ID by selecting “Manage Wunderground” on the submenu:

| WU Stations |  | Add    |
|-------------|--|--------|
| I44JIUXI35  |  | Delete |
| I44JIUXI28  |  | Delete |
| I44JIUXI60  |  | Delete |
| I44JIUXI74  |  | Delete |
| IFJELL37    |  | Delete |
| I44JIUXI65  |  | Delete |
| I44JIUXI71  |  | Delete |
| IU5E7FU414  |  | Delete |
| KCAMOUNT191 |  | Delete |
| I44JIUXI36  |  | Delete |
| IU5E7FU429  |  | Delete |

**Figure 27**

## 7.7 Settings

You can set your desired display units or default home page for the app by selecting “Settings” on the submenu:

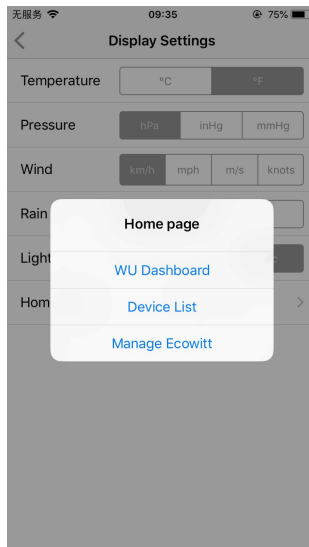

**Figure 28**

## 7.8 Manage Ecowitt

Once you created your ecowitt account successful on the WS View Plus app, you may select “Manage Ecowitt” on the submenu to manage your device.

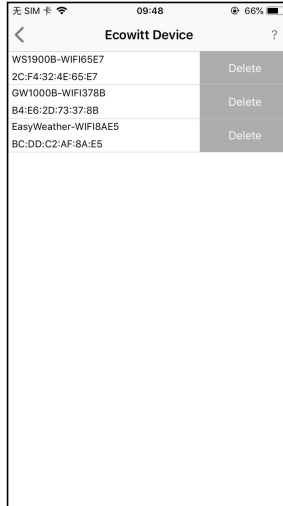

You may view your weather station data by pressing your device on this screen:

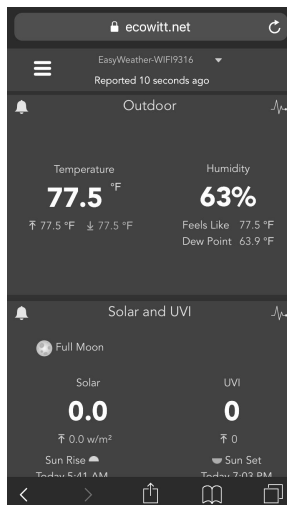

# 8 Maintenance

The following steps should be taken for proper maintenance of your station

1. Clean the rain gauge once every 3 months. Rotate the funnel counter-clockwise and lift to expose the rain gauge mechanism, and clean with a damp cloth. Remove any dirt, debris and insects. If bug infestation is an issue, spray the array lightly with insecticide.



**Figure: Rain gauge installation and maintenance**

2. Clean the solar radiation sensor and solar panel every 3 months with a non-abrasive slightly damp cloth.
3. Replace batteries every 1-2 years. If left in too long, the batteries may leak due to environmental challenges. In harsh environments, inspect the batteries every 3 months (while cleaning the solar panel).

4. When replacing the batteries, apply a corrosion preventing compound on the battery terminals, available at Amazon and most hardware stores.
5. In snowy environments, spray the top of the weather station with anti-icing silicon spray to prevent snow build up.

# 9 Troubleshooting Guide

Look through the following table and locate an issue or problem you are experiencing in the left column and read possible solutions in the right column.

| Problem  | Solution   |
|--|--|
| <p>Outdoor sensor not reporting to console</p> <p>Dashes (--) on the display console</p> | <p>Check that the outdoor transmission LED on the bottom is flashing approximately every 16 seconds. See Figure 1 item 10.</p> <p>If the batteries were recently (re)placed, check correct polarity was used and/or reseal the batteries. If the batteries are old, replace them.</p> <p>If the LED is now flashing every 16 seconds, proceed to the next step. If it is not flashing and you have repeated battery checks and placement, you may have a defective unit.</p> <p>Make sure you have fresh batteries in the display console.</p> <p>If the batteries may have been changed in the remote and/or the console, and the console has not been reset, the solution may be as simple as <b>powering cycling</b> the console: remove both batteries and external adapter for about 10 seconds and reconnect.</p> <p>If you still have problems, bring the outdoor sensor to a location about 10 ft. away from the console for testing. Power cycle the console as described above.</p> <p>Do not touch any buttons for several minutes to allow the console to “discover” the outdoor sensor. During this process the remote sensor search icon will flash on the display. Wait several minutes for this icon to turn off.</p> <p>If the search icon turns off and the outdoor temperature and humidity are still showing dashes (--), the remote</p> |

| Problem  | Solution  |
|--|---|
|  | <p>sensor is defective. If the sensor properly syncs up, proceed to the next step “Intermittent problems with outdoor sensor reception on console.”</p>   |
| <p>Intermittent problems with outdoor sensor reception on console</p>              | <p>There may be a temporary loss of communication due to signal quality issues caused by electrical interference or other location related factors (obstacles along line of sight).</p> <p>To troubleshoot, install a fresh set of batteries in the remote sensor array and console. For cold weather environments, install lithium batteries.</p> <p>If problems remain with fresh batteries, ensure power adapter is not too close to the console, and the console is not close to other electrical noise generating devices such as TVs, monitors, computers and transmitting devices.</p> <p>If you still have intermittent problems move sensor and console closer together, but not closer than 5 ft. Also check that there are no metal barriers like aluminum siding, or metal wall framing, along the line of sight between sensor and console. Relocate sensor and console as necessary to avoid obstacles.</p> <p>Depending on natural barriers you may also have to move the outdoor sensor higher and/or closer.</p> |
| <p>Indoor temperature sensor reads too high in the day time, and/or night time</p> | <p>Make sure the thermo-hygrometer is mounted in an indoor area where it will not be exposed to direct sunlight, our radiative heating, or convective heating.</p>  |
| <p>Indoor and Outdoor Temperature do</p>   | <p>During installation testing it is useful to test with both console and outdoor unit in the same room. Allow up to one hour for the sensors to stabilize and adjust to room</p>   |



| Problem  | Solution   |
|--|--|
| not agree during indoor testing                                  | temperature. The indoor and outdoor temperature sensors should agree within 4 °F (the sensor accuracy is $\pm 2$ °F). If these values still disagree, use calibration offsets for one or both sensors (see section 6.9.3) to adjust to a known good reference temperature.   |
| Indoor and Outdoor Humidity do not agree during indoor testing   | The procedure here is that same as for outdoor/indoor temperature. The sensors should agree within 10 % (the sensor accuracy is $\pm 5$ %) If these values still disagree, use calibration offsets for one or both sensors (see section 6.9.3) to adjust to a known good reference humidity.   |
| Relative pressure does not agree with official reporting station | Relative pressure refers to sea-level equivalent temperature and should generally agree closely with the official station. If there is a disagreement, make sure you are not looking at absolute pressure, in particular if your station is not near sea level. Also check at different times due to occasional delays in updates to the official station. Redo the pressure calibration procedure described in section 6.9.3.<br>The barometer is only accurate to $\pm 0.09$ inHg (3 hPa) within the following relative pressure range: 20.67 to 32.50 inHg (700 – 1,100 hPa), which corresponds to an altitude of 9,000 ft. (2,750 m) down to 2,500 ft. (750 m) below sea level. At higher altitudes, you should expect a possible lesser accuracy and non-linearity effects in the error (the calibration offset only allows for a partially linear correction). |
| Data not reporting to Wunderground.com                           | Confirm your station ID is correct. The station ID is all caps, and the most common issue is substituting a capital letter O for a 0 (zero) or vice versa. Please note the digit 0 can only occur in the last part of the station ID (which is a station number in a city). Example, KAZPHOEN11,   |

| Problem             | Solution   |
|---------------------|--|
|                     | <p>not KAZPH0EN11</p> <p>If there's a number "1" on the station key, try to input the lower case of letter "L" to replace it on the app.</p> <p>Confirm that your password (also called: button) is correct. It is the password wunderground.com generated for your station ID. You can also verify it by logging in to wunderground.com and looking it up under “My PWS.”</p> <p>Check your router firewall settings. The console sends data via port 80. If you can access other web sites using “http” (not to be confused with “https”) this setting will be OK.</p>   |
| No Wi-Fi connection | <p>Check for Wi-Fi symbol on the display. If wireless connectivity is operational, the Wi-Fi icon  will be displayed in the time segment on the console.</p> <p>If the symbol is not displayed, but you do remember configuring it successfully before, check that the console external power adapter is plugged in and functional. Wi-Fi use demand more energy than batteries alone can provide.</p> <p>If you have never been able to configure Wi-Fi to a working state, make sure your Wi-Fi supports 2.4 GHz signals (801 type B or G, or N). The console does <b>not support</b> Wi-Fi that uses the 5 GHz spectrum.</p> <p>Make sure you configured the correct SSID and password. Repeat the procedure if necessary to verify.</p> <p>The console does not support so-called “captive Wi-Fi” networks. These are typically “guest” type networks where users have to agree to terms and conditions before being connected.</p> |

## 10 Glossary of Common Terms

| TERM  | DESCRIPTION   |
|---|---|
| <b>ABSOLUTE AIR PRESSURE</b><br><b>ABSOLUTE BAROMETRIC PRESSURE</b> | Absolute air pressure is the air pressure registered on a barometer without regard to altitude.   |
| <b>BAROMETER</b>  | A barometer is a device that measures the pressure of the air pushing on it—this measurement is called the barometric pressure. We don't actually feel the barometric pressure because the air pressure is pushing equally in every direction.                        |
| <b>BEAUFORT (Bft)</b>   | An indicator of wind force strength (not speed) as it would act on a ship's sails. Still commonly in used in some locales to indicate wind force.   |
| <b>DEW POINT</b>  | The temperature to which air must be cooled to become saturated with water vapor. When further cooled, the airborne water vapor will condense to form liquid water (dew), or frost if below freezing.   |
| <b>HEAT INDEX</b>   | The heat index (HI) or humiture is an index that combines air temperature and relative humidity, in shaded areas, as an attempt to determine the human-perceived equivalent temperature, as how hot it would feel if the humidity were some other value in the shade. |
| <b>HECTOPASCALS (hPa)</b>   | This is an international standard (SI system) for measuring air pressure. It used to be referred to as milli-bar (mb) and sometimes still is. They are equivalent.  |
| <b>HYGROMETER</b>   | An instrument that measure relative humidity of the air. This is expressed as a percentage between 0% and 100%.   |

| <b>TERM</b>   | <b>DESCRIPTION</b>   |
|---|--|
| <b>INCHES OF MERCURY (inHg)</b>                               | This is the common unit of measurement for air pressure in the United States. It refers to the length of a standard column of mercury (a liquid metal) that can be pushed up by the ambient air pressure. Standard pressure is approximately 29.92 inHg  |
| <b>KNOTS (kn)</b>   | One knot is equivalent to one nautical mile and is sometimes used to indicate wind speed.  |
| <b>LCD</b>  | An acronym for “Liquid Crystal Display.” This is a common type of display screen used in televisions, computers, watches, and digital clocks.  |
| <b>LUX (lx)</b>   | The unit of illuminance (a measure of the intensity of illumination on a surface) as used in the SI system.  |
| <b>MILLIBAR (mb)</b>  | See HECTOPASCALS.  |
| <b>MM OF MERCURY (mmHg)</b>                                   | This is similar to inches of mercury, except expressed in millimeters. Standard pressure is approximately 760 mmHg.  |
| <b>RELATIVE AIR PRESSURE<br/>RELATIVE BAROMETRIC PRESSURE</b> | Relative air pressure is the absolute air pressure compensated for the altitude of the barometer. The result is what the air pressure would be at sea level.   |
| <b>ULTRA VIOLET INDEX</b>                                     | The ultraviolet index or UV-Index (UVI) is an international standard measurement of the strength of sunburn-producing ultraviolet (UV) radiation at a particular place and time. The purpose of the UV Index is to help people effectively protect themselves from UV radiation. The UV Index is a linear scale, with higher values representing a greater risk of sunburn (which is correlated with other health risks) due to UV exposure. An index of 0 corresponds to zero UV radiation, as is essentially the case at night. An index of 10 corresponds roughly to midday |

| TERM              | DESCRIPTION  |
|-------------------|--|
|                   | summer sunlight with a clear sky when the UV Index was originally designed, but values above 10 are sometimes possible. Levels above 8 are considered “very high” and above 11 are considered “extreme.”                                 |
| <b>WIND CHILL</b> | Wind chill (popularly wind chill factor) is the lowering of body temperature due to the passing-flow of lower-temperature air. In other words, the air “feels” colder than it is because of the chilling effect of the wind on the skin. |

**Table 10: Glossary of terms**

# 11 Specifications

**Note:** Out of range values will be displayed using “---”:

| Outdoor sensor                      | Specification   |
|-------------------------------------|---|
| Transmission distance in open field | 100 m (330 ft.)   |
| RF Frequency                        | 433/868/915 MHz depending on location   |
| Temperature range                   | -40°C – 60°C (-40°F - 140°F)  |
| Temperature accuracy                | ± 1°C, or ± 2°F   |
| Temperature resolution              | 0.1°C, or 0.1°F   |
| Humidity range                      | 10% ~ 99%   |
| Humidity accuracy                   | ± 5%  |
| Humidity resolution                 | 1%  |
| Rain volume display range           | 0 – 6000 mm   |
| Rain volume accuracy                | ± 10%   |
| Rain volume resolution              | 0.3 mm (for volume < 1,000 mm)<br>1 mm (for volume ≥ 1,000 mm), or<br>0.01 in (for volume < 100 in)<br>1 mm (for volume ≥ 100 in) |
| Wind speed range                    | 0 – 50 m/s (0 ~ 100 mph)  |
| Wind speed accuracy                 | ± 1 m/s (speed < 5 m/s)<br>± 10% (speed ≥ 5 m/s), or<br>± 0.1 mph (speed < 11 mph)<br>± 10% (speed ≥ 11 mph)                      |
| UV-Index range                      | 0 - 15  |
| Light range                         | 0 – 200 kLux  |
| Light accuracy                      | ± 15%   |
| Sensor reporting interval           | 16 seconds  |

**Table 11: Outdoor sensor specification**

| <b>Indoor sensor</b>           | <b>Specification</b>             |
|--------------------------------|----------------------------------|
| Temperature range              | -10°C – 60°C (14°F - 140°F)      |
| Temperature resolution         | 0.1°C, or 0.1°F                  |
| Humidity range                 | 10% ~ 99%                        |
| Humidity resolution            | 1%                               |
| Barometric pressure range      | 700-1100hPa (20.67-32.5inHg)     |
| Barometric pressure accuracy   | ± 3 hPa in 700 – 1,100 hPa range |
| Barometric pressure resolution | 0.1 hPa (0.01 inHg)              |
| Alarm duration                 | 120 sec                          |
| Sensor reporting interval      | 60s                              |

**Table 12: Indoor sensor specification**

| <b>Power</b>            | <b>Specification</b>  |
|-------------------------|---|
| Base station/console    | 5V DC adaptor (included), Power Consumption: 0.5 Watts (1.25 Watts during Wi-Fi configuration mode) |
| Base station/console    | 3 x AAA batteries (not included)  |
| Outdoor sensor          | Solar panel (built-in)  |
| Outdoor sensor (backup) | 2 x AA 1.5V LR6 Alkaline (not included), or 2 x AA 1.5V Lithium battery (not included)              |

**Table 13: Power specification**

The primary power source for the outdoor sensor is the solar panel. When available solar power (light over recent period) is insufficient, the batteries will be used. In outdoor climates that frequently have sustained temperatures below 0°C (or 32°F) the use of Lithium batteries is strongly suggested as these are performing better than Alkaline batteries under such circumstances.

## **12 Warranty Information**

**We disclaim any responsibility for any technical error or printing error, or the consequences thereof.**

**All trademarks and patents are recognized.**

We provide a 1-year limited warranty on this product against manufacturing defects, or defects in materials and workmanship.

This limited warranty begins on the original date of purchase, is valid only on products purchased, and only to the original purchaser of this product. To receive warranty service, the purchaser must contact us for problem determination and service procedures.

This limited warranty covers only actual defects within the product itself and does not cover the cost of installation or removal from a fixed installation, normal set-up or adjustments, or claims based on misrepresentation by the seller, or performance variations resulting from installation-related circumstances.